

MOSO[®] Bamboo UltraDensity[®]

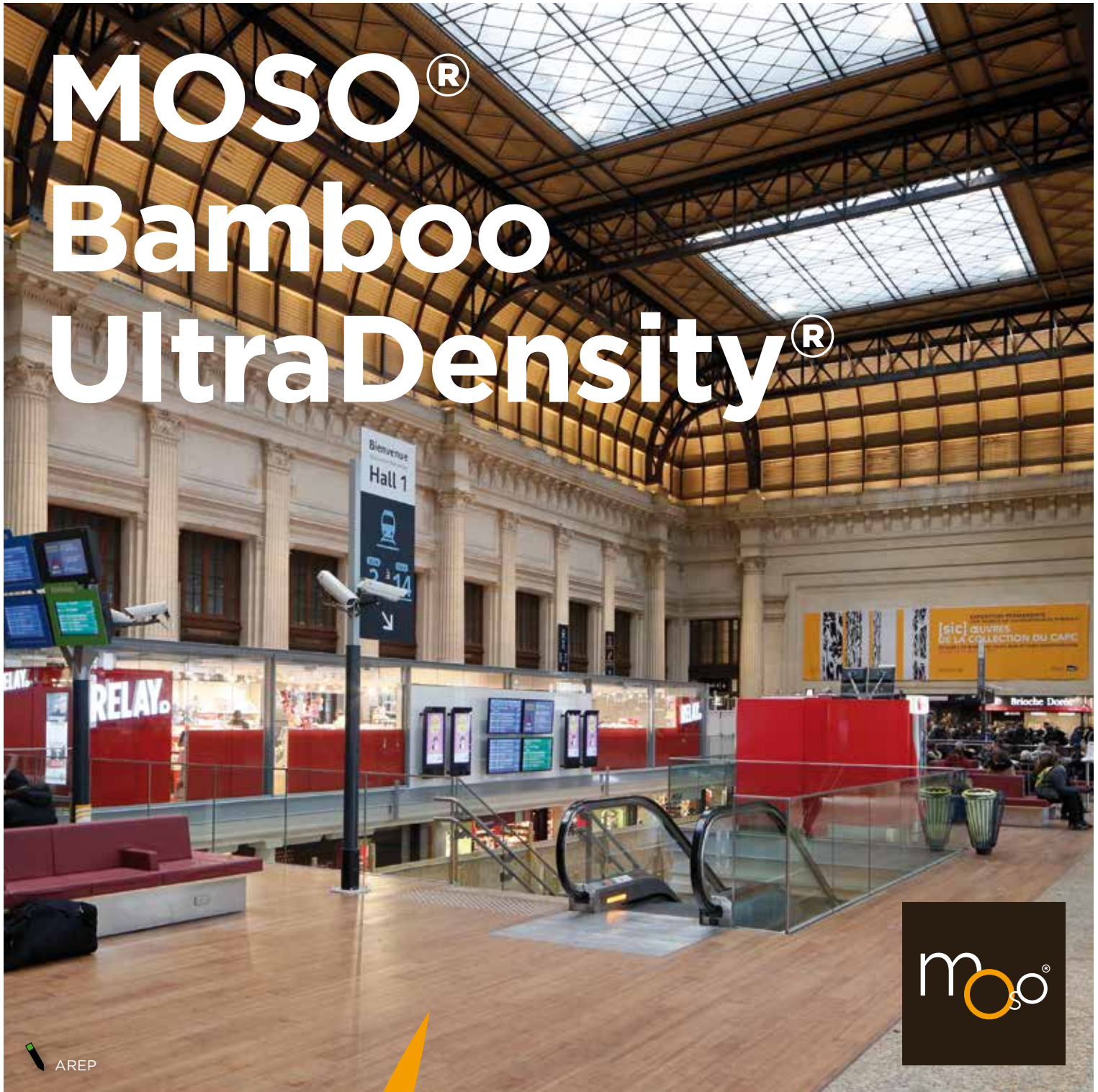

AREP

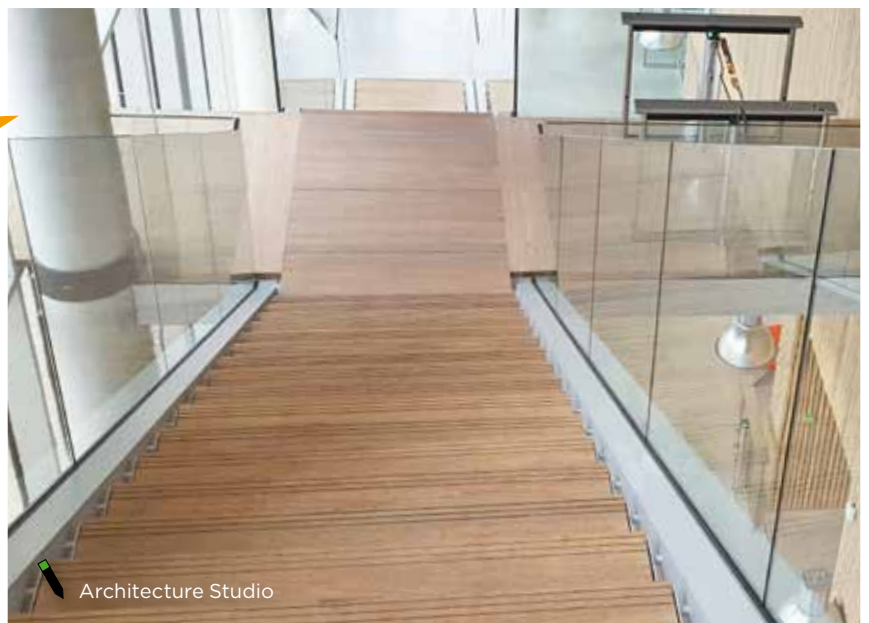

Architecture Studio

discover the **Bamboo** UltraDensity® benefits

With Bamboo UltraDensity®, MOSO has developed a truly ecological and durable solution for heavy duty natural flooring for indoor or semi-outdoor applications (protected from direct rain or sunshine). For Bamboo UltraDensity®, the bamboo stems are split into strips, then crushed and finally compressed into boards. This results in boards with an Ultra-High Density®, which makes the bamboo extremely durable and suitable for almost any high traffic area. **Bamboo UltraDensity® is the only alternative to stone, ceramic, pvc or other industrial floors!**

This unique product is supplied in different thicknesses, from 18 to 38 mm, and formats including flooring boards and stair panels. The flooring can be installed glued down indoors or fixed on sub beams in covered outdoor areas. Certified by the French Wood institute FCBA and the French Building Institute CSTB, this product has achieved the highest certifications in terms of stability, fire resistance, wear and mark resistance. The mechanical properties allow for intense use with heavy traffic as a solution for railway stations, airports, museums, and any other public area.



suitable in tough conditions:
very high traffic (covered outdoor) areas



durable

- The only 'woodlike' material that is U₄P₄E₂C₂ classified by the French wood institute CSTB.
- Use Class 3.1 according to EN 335 when installed screwed down on sub beams.
- Chemical resistance higher than any wood for similar applications, according to XP B 53-669 and EN 13442, when coated with Woca N°1 oil.
- Wear layer up to 14 mm.



hard

- Exceptionally hard: Brinell ≥ 9.5 kg/mm² (harder than any wood available).
- Mechanical resistance reaches highest class possible according to EN 408 / EN 310.
- Mechanical properties are better than tropical wood.

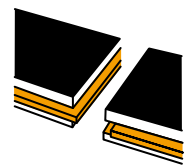

high stability

- Water resistance approx. 15 times higher than any wood for similar applications, according to ISO 24339.
- Far more stable than any hardwood - enabling tongue and groove connection (4 sides).
- No gap necessary between flooring boards (in semi-outdoor applications), no expansion gap within a 15 m wide x 100 m long area.



fireproof

- Reaches fire safety class Bfl-s1 following EN 13501-1 without use of fire retardants.
- Fire resistance properties are better than any natural material including wood.
- Can be easily used in public projects without additional measures.



beautiful appearance

- A beautiful, natural hardwood look.
- With tongue and groove installation no visible screw holes.
- Free of knots and natural plant resins.
- Large surfaces without expansion gaps give endless design opportunities.



endless resource

- Made from Moso bamboo; With a growing speed of up to 1 meter per day the fastest growing plant on earth.
- Ready for harvest after 5 years (compared to up to 100 years for hardwood species) - no deforestation.
- Consisting of approx. 93% natural bamboo.



CO₂ neutral

- Official LCA and carbon footprint studies by Technical University Delft according to ISO 14040/44 confirm that MOSO® Bamboo UltraDensity® is CO₂ neutral over the full life cycle.
- No use of fungicide in the production.



covered outdoor areas

- Can be used installed screwed down on sub beams in semi-outdoor areas (protected from direct rain or sunshine).
- Can withstand high temperature differences, and high moisture differences thanks to its high stability.

MOSO® bamboo ultradensity® flooring

(for semi-outdoor high traffic areas for installation with MOSO® Bamboo X-treme® sub beams)

MOSO® Bamboo UltraDensity® is a solid bamboo flooring board made from compressed bamboo strips with an Ultra-High Density®. Thanks to its unique production method the material is extremely stable, hard and durable and therefore suitable for the toughest conditions: in very high traffic areas and even in semi-outdoor areas (protected from direct rain or sunshine). The boards are available unfinished, with rough sanded faces and have to be finished on site. The boards come with tongue and groove and a micro bevel on all 4 sides. This flooring type has to be installed screwed down on MOSO® Bamboo X-treme® sub beams or alternative sub beams.

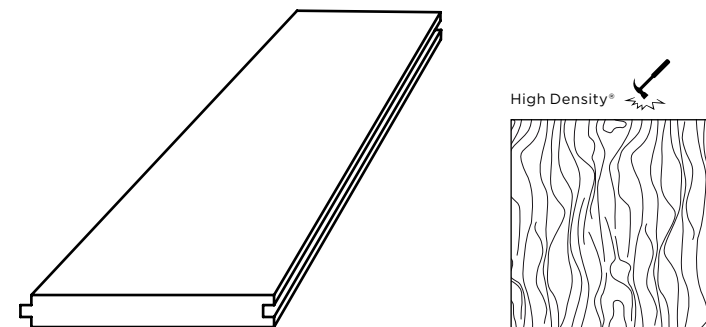

The full MOSO® Bamboo UltraDensity® flooring system, to be installed on MOSO® Bamboo X-treme® sub-beams, with peripheral joints and surface finishing with Woca N°1 products (oil and soaps), is intended for installation in premises classified up to U₄P₄E₂C₂ within the loading limits corresponding to this classification*. This Technical field has been registered at CSTB under the number ATE_x 2385.

* (see Note on UPEC classification and UPEC classification of premises, e-CSTB n°3509 of November 2004) Installation takes place on new or existing substrates made of concrete or cement mortar taking into account the humidity and flatness conditions defined in NF DTU 51.2. Wood-based substrates and screeds containing calcium sulfate are excluded. The use of this method is limited to Class 2 (according to Eurocode 5) and Class of use 3.1 (according to EN 335).

HD: High Density®, B: Bevel

Caramel	Style	Finish	Edges	Dimensions (mm)
BF-DS1070	HD	-	B	1900x160x38
BF-DS1060	HD	-	B	1900x160x32
BF-DS2060	HD	-	B	1900x160x20

approved by ATE_x n° 2385
on the 19th of December 2016



Class U₄P₄E₂C₂



installation summary (full version available on www.moso.eu/ultradensity)

- Install a PE (Polyethylene) film as moisture barrier.
- Install a suitable, fixed, stable and durable sub frame, preferably using Bamboo X-treme® sub beams. Distance between the beams: see table 'field of use' (page 7).
- Always make sure the end of the board is supported by a joist.
- Maximum length/width of the floor 100 m / 15 m.
- Fix the boards on the sub frame screwing into the tongue of the board at a 45° angle. Always predrill before screwing.
- After cleaning and drying, apply an appropriate finish (Woca N°1 is advised for heavy traffic areas).
- After installation: make sure proper cleaning and maintenance is done, according to the chosen finish.
- For further information: please see the installation and maintenance instructions.

technical characteristics and certifications

- Density (product): +/- 1150 kg/m³
- Composition: 93% bamboo strips (lignin/cellulose) and 7% glue (outdoor resistance).
- Top layer thickness / Wear layer: approx. 7 mm for the 20 mm boards / 11 mm for the 32 mm boards / 14 mm for the 38 mm boards.
- Dimensional stability: Results conform to French standard NF B 54008 (ISO 24339).
- Resistance to Indentation - Brinell Hardness: ≥ 9.5 kg/mm² (EN 1534)
- Reaction to fire¹⁾: Class Bfl-s1 (EN 13501-1)
- Slip resistance²⁾: USRV 118 (EN 13036-4), R10 (CEN/TS 16165 Annex B - DIN 51130)
- Emission of VOC: A+ (ISO 16000-9)
- Modulus of Elasticity: 12610 N/mm² (EN 408)
- Breaking strength: 95.5 N/mm² (EN 310)
- Biological durability: Class 2 (EN 350 / CEN/TS 15083-1)
- Use class: Class 3.1 (EN 335 / EN 460)
- Use classification according to French standard: Class 41 (XP B 53-669)
- UPEC classification according to French standard: Class U₄P₄E₂C₂¹⁾
- CO₂ neutral: LCA report TU Delft (ISO 14040/44) (www.moso.eu/lca)
- Environmental Product Declaration - EPD (EN 15804) (www.moso.eu/epd)
- FSC®: Products available with FSC® certification on request.
- Contribution LEED BD+C - v4: MR 1, MR 2, MR 3 (FSC®), EQ2 v2009: MR 6, MR 7 (FSC®), IEQ 4.4
- Contribution BREEAM: HEA 2, MAT 1, MAT 3 (FSC®), MAT 5
- Guarantee: 30 years

¹⁾ only when finished with Woca N°1 oil.



The mark for responsible forestry
FSC® C002063
www.fsc.org
Only the products defined as such,
are FSC certified



breem

MOSO® bamboo ultradensity® flooring

(for high traffic areas for installation with glue)

MOSO® Bamboo UltraDensity® is a solid bamboo flooring board made from compressed bamboo strips with an Ultra-High Density®. With its unique production method the material is extremely stable, hard and durable and therefore suitable for high traffic areas. The boards are available unfinished, and have to be finished on site. The boards come with tongue and groove and a micro bevel on all 4 sides. This flooring type has to be fully glued down.

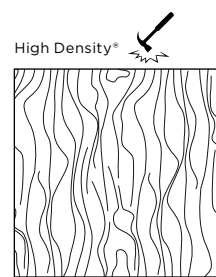
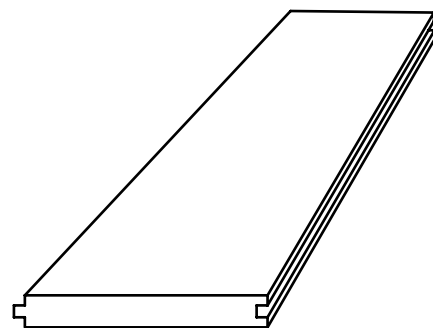

HD: High Density®, MB: Micro bevel

Caramel	Style	Finish	Edges	Dimensions (mm)
BF-DS2061	HD	-	MB	1900x160x18

MOSO® bamboo ultradensity® & x-treme® stair panels

The MOSO® Bamboo Stair Panel is a solid bamboo board, made from compressed bamboo strips. The compression process makes MOSO® Bamboo Stair Panels very dense, hard and stable. Both products have been certified and their mechanical properties allow for structural applications such as stairs. MOSO® offers 2 different types of Stair Panels:

Bamboo UltraDensity® Stair Panel is suitable for semi-outdoor covered areas and indoor applications (Use Class 3 / EN 335). These planks have a warm brown caramel colour.

Bamboo X-treme® Stair Panel is suitable for full outdoor use (Use Class 4 / EN 335), thanks to the Thermo-Density® production process. The bamboo strips are heat-treated and compressed. These planks have a dark chocolate colour.

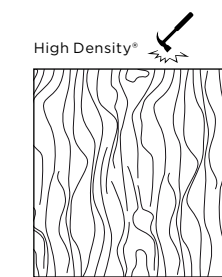
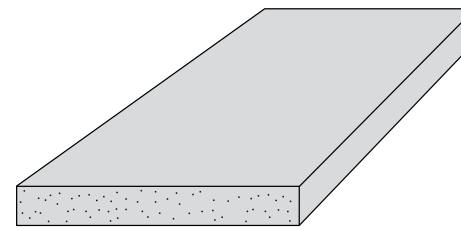

HD: High Density®, SE: Sharp Edge

Version	Caramel	Chocolate	Style	Finish	Edge	Thickness (mm)	Dimensions (mm)
UltraDensity®	BP-DS1080		HD	-	SE	38	2440x320
Bamboo X-treme®		BP-DTHT1080	HD	-	SE	38	2440x320

- The look may be different compared to High Density® flooring, please check before ordering if the products can be combined.
 - Because of the High Density® of the UltraDensity® products the surface is very closed.
 For Bamboo X-treme® the material is produced from heat-treated strips and even with High Density® it can have some open pores.

Installation summary (full version available on www.moso.eu/ultradensity)

- Check room climate conditions (room temp. 18-21°C, air humidity 40-65%).
- Check subfloor: it should be flat/clean/stable and should not exceed the maximum allowed moisture content (for example 1.8% for sand cement).
- The floor should be fully glued.
- Elastic adhesive systems like 1-component Polyurethane or silan type of adhesives only can be used, when:
 - Shear strength Ts > 1.4 N/mm² (3 days balanced at 23 degrees Celsius/50% Air Humidity)
 - Shear elongation y >= 0.5 (3 days balanced at 23 degrees Celsius/50% Air Humidity)
- Please ask your glue supplier for more information.
- After cleaning and drying, apply an appropriate finish (Woca N°1 is advised for heavy traffic areas).
- This floor type can be installed - under certain conditions - on floor heating / cooling.

Technical characteristics and certifications

- Density (product): +/- 1150 kg/m³
- Composition: 93% bamboo strips (lignin/cellulose) and 7% glue (outdoor resistance)
- Top layer thickness / Wear layer: approx. 7 mm
- Dimensional stability: Results confirms to French standard NF B 54008 (ISO 24339)
- Resistance to Indentation - Brinell Hardness: ≥ 9.5 kg/mm² (EN 1534)
- Reaction to fire¹⁾: Class Bfl-s1 (EN 13501-1)
- Emission of VOC: A+ (ISO 16000-9)
- Use class: Class 3.1 (EN 335 / EN 460)
- Use classification according to French standard: Class 41 (XP B 53-669)
- UPEC classification according to French standard: Class U₄P₄E₂C₂¹⁾
- CO₂ neutral: LCA report TU Delft (ISO 14040/44) (www.moso.eu/lca)
- Environmental Product Declaration - EPD (EN 15804) (www.moso.eu/epd)
- FSC®: Products available with FSC® certification on request.
- Contribution LEED BD+C - v4: MR 1, MR 2, MR 3 (FSC®), EQ2 v2009: MR 6, MR 7 (FSC®), IEQ 4.4
- Contribution BREEAM: HEA 2, MAT 1, MAT 3 (FSC®), MAT 5
- Guarantee: 30 years

¹⁾ only when finished with Woca N°1 oil

Technical characteristics and certifications

Bamboo UltraDensity® Stair Panel

- Density: +/- 1150 kg/m³
- Dimensional stability: Results conform to French standard NF B 54008 (ISO 24339)
- Resistance to Indentation - Brinell Hardness: ≥ 9.5 kg/mm² (EN 1534)
- Reaction to fire: Class Bfl-s1 (EN 13501-1)
- Formaldehyde emission: < 0.124 mg/m³, EN 717-1)
- VOC emission: A+ (ISO 16000-9)
- Modulus of Elasticity: 12610 N/mm² (EN 408)
- Breaking strength: 95.5 N/mm² (EN 310)
- Biological durability: Class 2 (EN 350 / CEN/TS 15083-1)
- Use Class: Class 3.1 (EN 335 / EN 460)
- CO₂ neutral: LCA report TU Delft (ISO 14040/44) (www.moso.eu/lca)
- Environmental Product Declaration - EPD (EN 15804) (www.moso.eu/epd)
- FSC®: Products available with FSC® certification on request.
- Contribution LEED BD+C - v4: MR 1, MR 2, MR 3 (FSC®), EQ2 v2009: MR 6, MR 7 (FSC®), IEQ 4.4
- Contribution BREEAM: HEA 2, MAT 1, MAT 3 (FSC®), MAT 5
- Guarantee: 30 years

Technical characteristics and certifications

Bamboo X-treme® Stair Panel

- Density: +/- 1150 kg/m³
- Dimensional stability: length: + 0.1 %; width + 0.9% (24 hours in water 20°C)
- Resistance to Indentation - Brinell Hardness: ≥ 8.7 kg/mm² (EN 1534)
- Reaction to fire: Class Bfl-s1 (EN 13501-1)
- Modulus of Elasticity: 10373 N/mm² (EN 408)
- Breaking strength: 50.30 N/mm² (EN 408)
- Biological durability: Class 1 (EN 350 / CEN/TS 15083-2), simulated graveyard test Class 1 (EN 350 / CEN/TS 15083-1)
- Effectiveness against Blue Stain: Class 0 (EN 152)
- Use Class: Class 4 (EN 335 / EN 460)
- CO₂ neutral: LCA report TU Delft (ISO 14040/44) (www.moso.eu/lca)
- Environmental Product Declaration - EPD (EN 15804) (www.moso.eu/epd)
- FSC®: Products available with FSC® certification on request.
- Contribution LEED BD+C - v4: SS 7, MR 1, MR 2, MR 3 (FSC®) v2009: MR 6, MR 7 (FSC®)
- Contribution BREEAM: MAT 1, MAT 3 (FSC®), MAT 5
- Guarantee: 10 years

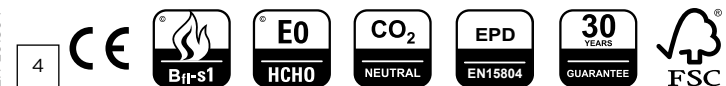

The mark for responsible forestry FSC® CO02063 www.fsc.org Only the products defined as such, are FSC certified

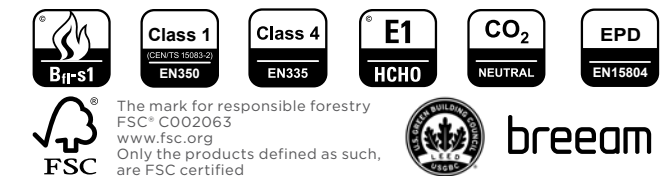
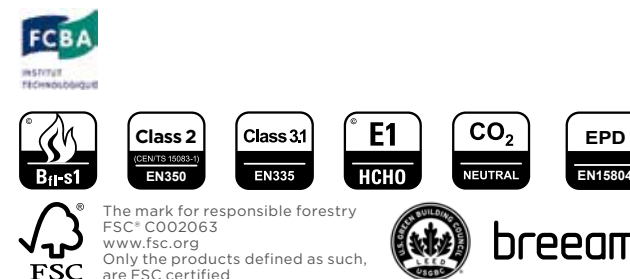

MOSO® bamboo x-treme® sub beams

MOSO® Bamboo X-treme® sub beams are solid, High Density® beams, made from compressed bamboo strips. A special, patented Thermo-Density® heat treatment process at 200°C gives MOSO® Bamboo X-treme® the highest durability class possible in the appropriate EU norms and increases the hardness and stability. The sub beams are the most suitable under construction for Bamboo UltraDensity® flooring.

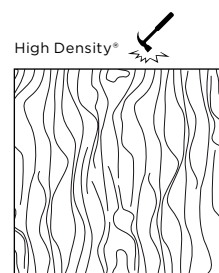
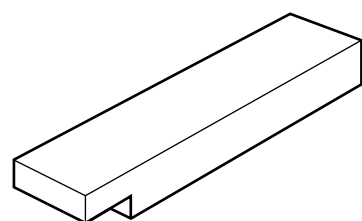

Product Code	Material	Finish	Dimensions (mm)
BO-SB150	Thermo Density® bamboo	Unfinished	2440x70x40
BO-SB155	Thermo Density® bamboo	Unfinished	2440x60x40

- The MOSO® Bamboo X-treme® sub beams can be produced with special profiles on request.

technical characteristics and certifications

- Density: +/- 1150 kg/m³
- Dimensional stability: length: + 0.1%; width + 0.9% (24 hours in water 20°C)
- Resistance to Indentation - Brinell Hardness: ≥ 8.7 kg/mm² (EN 1534)
- Reaction to fire: Class Bfl-s1 (EN 13501-1)
- Modulus of Elasticity: 10373 N/mm² (EN 408)
- Breaking strength: 50.30 N/mm² (EN 408)
- Biological durability:
 - Class 1 (EN 350 / CEN/TS 15083-2), simulated graveyard test
 - Class 1 (EN 350 / CEN/TS 15083-1)
- Effectiveness against Blue Stain: Class 0 (EN 152)
- Use Class: Class 4 (EN 335 / EN 460)
- CO₂ neutral: LCA report TU Delft (ISO 14040/44) (www.moso.eu/lca)
- Environmental Product Declaration - EPD (EN 15804) (www.moso.eu/epd)
- FSC®: Products available with FSC® certification on request.
- Contribution LEED BD+C - v4: MR 1, MR 2, MR 3 (FSC®) v2009: MR 6, MR 7 (FSC®)
- Contribution BREEAM: MAT 1, MAT 3 (FSC®), MAT 5
- Guarantee: 10 years



The mark for responsible forestry
FSC® C002063
www.fsc.org
Only the products defined as such,
are FSC certified



breem

MOSO® bamboo ultradensity® system

(specially developed for semi-outdoor covered areas)

MOSO® Bamboo UltraDensity® has been certified as part of a full system, including:

- PE (Polyethylene) film on the ground – moisture barrier.
- Sub-beams Bamboo X-treme® installed floating and levelled on the ground.
- The flooring Bamboo UltraDensity® screwed on sub beams using stainless steel decking screws at a 45° angle.
- Pre-drilling is needed and the screws will be inserted in the tongue of the board.
- Boards will be installed using the tongue and groove system on 4 sides.
- Finishing with Woca N°1 oil and maintained / cleaned with Woca soap.
- Special joints (Veda) to be used for expansion gaps (required from 100 x 15 m – 1500 m²).
- Special Bamboo UltraDensity® skirting boards are available to ensure the right ventilation between the floor and the sub-surface, more information on request.

approved by ATEX n° 2385
on the 19th of December 2016

Class U₄P₄E₂C₂



MOSO® bamboo ultradensity® field of use

MOSO® Bamboo UltraDensity® flooring for installation on sub beams, with a thickness of 32 or 38 mm, can be installed in most areas, depending on the space between the sub beams.

Category of use	Spread load kg/m ²	Concentrated load kg/m ²	Space between sub beams (3)					
			300 mm	400 mm	500 mm	600 mm	700 mm	
A - Residential								
A1 - Floors	150	200	●	●	●	●	●	
A2 - Balconies	250	200	●	●	●	●	●	
A3 - Stairs	350	200	●	●	●	●	●	
B - Office areas	250	400	●	●	●	●	●	
C - Areas where people may congregate:								
C1 - with tables (e.g. restaurants, cafés, ...)	250	300	●	●	●	●	●	
C2 - with fixed seats (e.g. areas in churches, theatres or cinemas...)	400	400	●	●	●	●	●	
C3 - without obstacles for moving people (e.g. museums, exhibition rooms...)	400	400	●	●	●	●	●	
C4 - with possible physical activities (e.g. dance halls, gymnastic rooms...)	500	700	●	x	x	x	x	
C5 - susceptible to large crowds (e.g. train stations, airports, concert halls...)	500	450	●	●	●	●	x	
D1 - General retail shops	500	500	●	●	●	x	x	
D2 - Department stores	500	700	●	x	x	x	x	

- The mechanical properties of BF-DS1070 and BF-DS1060 are tested following EN 310 and EN 1533.
- This table is not applicable for other flooring products mentioned in this document.



Paper from responsible sources
FSC® C002063

find all the information about
MOSO® Bamboo UltraDensity® on:
www.moso.eu/ultradensity



approved by ATEX n° 2385
on the 19th of December 2016



Class U₄P₄E₂C₂



INSTITUT
TECHNOLOGIQUE

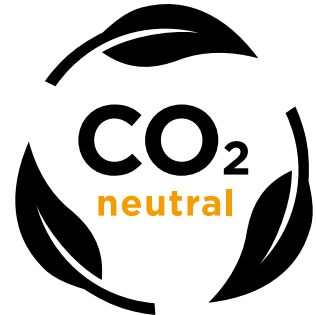

Headquarters:

Moso International B.V.

Adam Smithweg 2
1689 ZW Zwaag
the Netherlands
T +31 (0)229 265 732
info@moso.eu

Spain, France, Portugal, North Africa,
Latin America and Middle East:

Moso Europe S.L.U.

C/ Pau Claris, 83 - Principal 2ª
08010 Barcelona
Spain
T +34 (0)93 574 9610
contact@moso.eu

North America:

Moso North America Inc.

8400 B Remington Ave
Pennsauken, NJ 08110
United States of America
T: +1 855 343 8444
info@moso-bamboo.com

Sub-Saharan Africa:

Moso Africa Pty. Ltd.

7 Glosderry Road Kenilworth
7708 Cape Town
South Africa

T +27 2167 11214
contact@moso-bamboo.co.za

Gulf Cooperation Council (GCC)
Countries:

Moso Middle East LLC

202 Al Mansour Bldg.
Damascus Road, Al Qusais
P.O. Box: 384421, Dubai
United Arab Emirates
T: +971 4 258 9337

contact@moso.ae

Italy:

Moso Italia S.R.L.

Via Antonio Locatelli 86
20853 Biassono (MB)
Italy

T +39 (0)39 900 5440
mosoitalia@moso.eu

www.moso.eu



**bamboo
products**